

Home Chair

La poltrona giusta per gli ambienti contenuti



POLTRONA

Uso frequente

Chemioterapia

Terapia Infusionale

Donazione sangue

Prelievi

Pronto soccorso

Dialisi

Polifunzionali





PULSANTIERA 10 TASTI
CON 2 MEMORIE

Vantaggi

- Telaio antiribaltamento che assicura stabilità in ogni condizione operativa.
- Telaio verniciato con polveri epossidiche termoindurenti arricchite con antibatterico con vasto assortimento colori. Personalizzazione colore come da campionario.
- Superficie anatomica, estremamente ergonomica ed avvolgente che assicura il massimo comfort;
- Imbottitura dei cuscini realizzati in poliuretano espanso indeformabile.
- Due cuscini separati schienale e seduta/gambe, funzionali per: postura eccellente, ergonomia ed effetto preventivo delle lesioni da decubito.
- Configurabile con numerosi accessori funzionali ed esclusivi (consultare il catalogo accessori).
- Rivestimento realizzato in similpelle lavabile e certificato, con proprietà antibatteriche e antimicotiche. Piacevole al tatto ed estremamente resistente dotato delle seguenti caratteristiche: antibatterico, ignifugo classe 11M, antimicotico. Inoltre è resistente ad: alcool, perossido di idrogeno, ipoclorito di sodio max 5%, disinfettanti di uso comune e presidi medico chirurgici.
- Portata massima 180 kg.

Dotazioni di serie

- Telaio in acciaio verniciato realizzato con polveri termoindurenti arricchite con antibatterico. Colore personalizzabile - Scheda colori a pag 4.
- Piano suddiviso in 3 sezioni: schienale, seduta e gambe.
- Movimentazione simultanea e indipendente delle sezioni schienale e gambe tramite 2 motori - Codice dotazione AC12.
- Posizione di trendelenburg 10°.
- Sezione gambe 90° rispetto alla seduta - Codice dotazione AC63.
- Nr. 4 ruote durevoli (2 posteriori dotate di freno singolo), realizzate in acciaio inossidabile Ø 100 mm.
- Tutte le movimentazioni della poltrona sono comandate tramite pulsantiera perimetrale dotata di cavo spiralato da 3,5 m. La pulsantiera è di facile utilizzo poiché realizzata con grandi pittogrammi a rilievo e risulta adatta anche per pazienti ipovedenti. La pulsantiera è dotata di 10 tasti con 2 memorie. Per la sicurezza dei pazienti la pulsantiera è fornita di chiave per inibizione dei comandi - Codice dotazione AC34P. Isolamento IP66.
- Cuscini indipendenti e asportabili.
- Rivestimento similpelle ignifugo UNI 9175/87 e 9175FA-1/94 classe 11M - Codice dotazione AC87/1.



Movimentazioni

BRACCIOLO RIBALTABILE CON
DISPOSITIVO AUTOMATICO DI ROTAZIONE.
SEGUE L'INCLINAZIONE DELLO SCHIENALE
ASSICURANDO UNA CORRETTA E
CONFORTEVOLE POSTURA.

SEZIONE GAMBALE A 90°
RISPETTO ALLA SEDUTA



TRENDELENBURG -10°



ESTENSIONE/ELEVAZIONE MOTORIZZATA E
SINCRONIZZATA DELLA SEZIONE GAMBALE

















Scheda colori

























COLORI TELAIO

Tutta la struttura della poltrona è protetta da vernici epossidiche termoindurenti. Le vernici sono arricchite su richiesta di antibatterico. Se non specificato il dispositivo sarà realizzato bianco 9010.

 Codice 2004	 Codice 5012	 Codice 7035
 Codice 3020	 Codice 6027	 Codice 9005
 Codice 1018	 Codice 6018	 Codice 9010
 Codice 1021	 Codice 7001	 Codice 4010
 Codice 5010	 Codice 9006	

COLORI PER RIVESTIMENTO STANDARD

 Codice 5947	 Codice 0872	 Codice 0014
 Codice 5948	 Codice 4947	 Codice 0027
 Codice 0680	 Codice 1944	 Codice 0006
 Codice 0508	 Codice 4008	 Codice 0346
 Codice 0041	 Codice 1946	 Codice 016043
 Codice 0064	 Codice 4933	 Codice 011499
 Codice 0055	 Codice 0430	 Codice 015815
 Codice 1816	 Codice 0151	 Codice 015814
 Codice 0833	 Codice 0667	 Codice 016042

COLORI PER RIVESTIMENTO SILICONICO (CON MAGGIORAZIONE DI PREZZO) CODICE ACCESSORIO AC87



 Codice 7039.08	 Codice 7039.14	 Codice TH.439
 Codice 7039.06	 Codice TH.513	 Codice TH.438
 Codice 7039.17	 Codice TH.511	 Codice TH.322
 Codice 7039.20	 Codice TH.305	 Codice TH.224
 Codice 7039.10	 Codice TH.378	 Codice 312
 Codice 7039.19	 Codice TH.300	 Codice TH.226
 Codice 7039.13	 Codice TH.510	



Tabella dimensioni

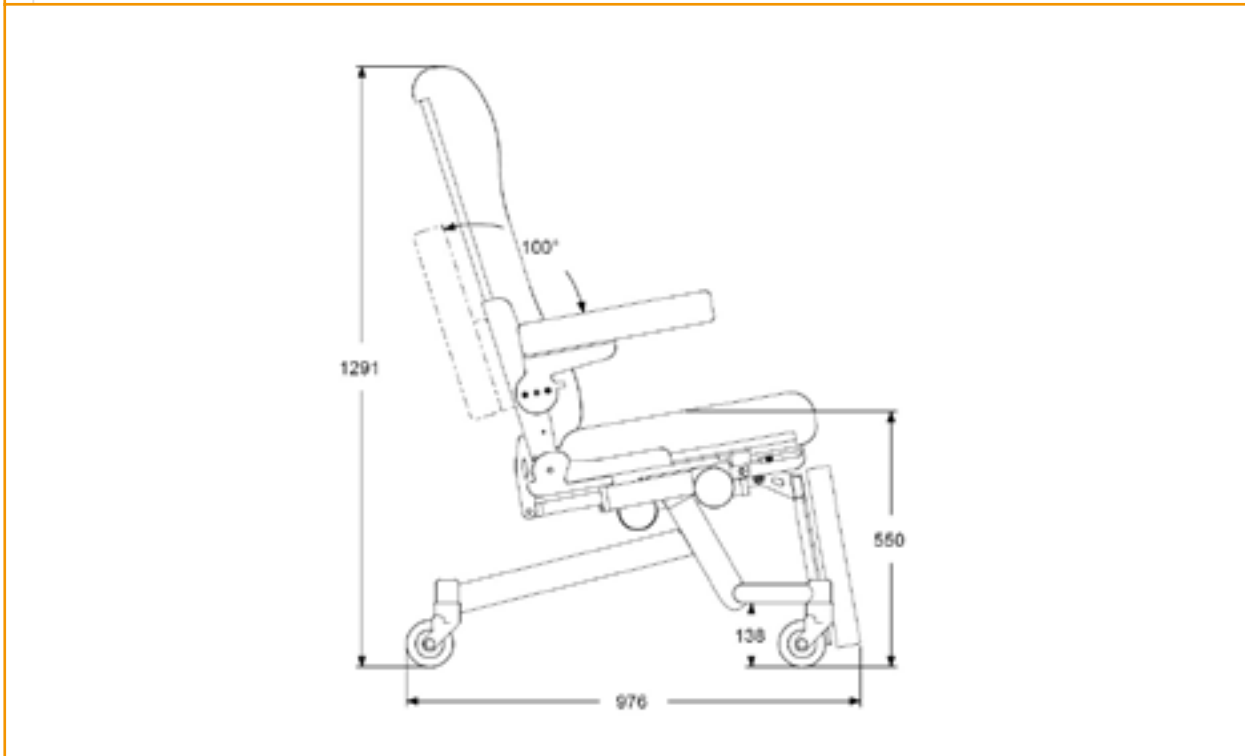
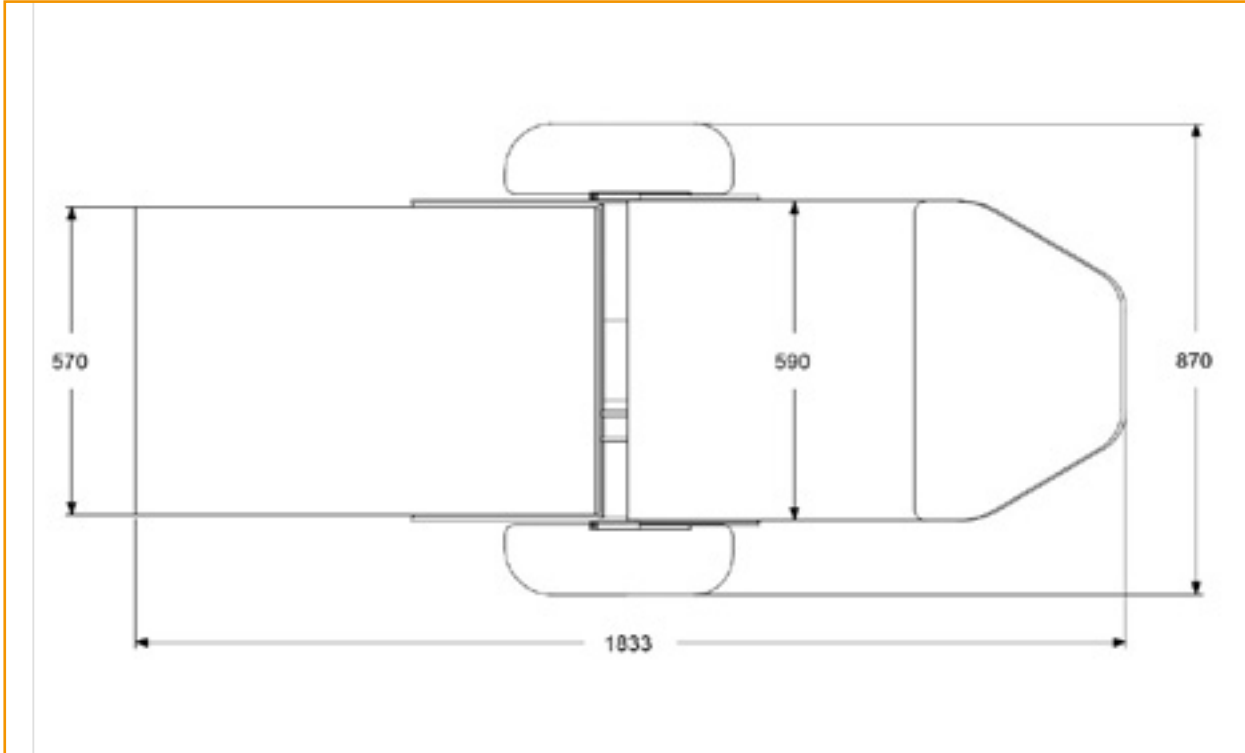

**TIPOLOGIA CAVO DI
ALIMENTAZIONE**

Tipo F - Schuko



Tipo L - 16A

Scheda tecnica

Codice CND	Z129008
N. progressivo/R	87249/R
Codice Prodotto	GB0138.SP Acciaio verniciato GB0138.SS Acciaio inox
Destinazione d'uso	Poltrona polifunzionale
Produttore	GARDHEN BALANCE SRL
Peso totale	70 kg
Ruote	Nr. 4 inossidabili girevoli da 100 mm (due posteriori dotate di freno singolo)
Alimentazione	100 - 240 Vac 50/60 Hz
Motori elettrici	Bassa tensione (24 V)
Assorbimento max	4A
Isolamento	IP44
Portata Massima	180 kg
Carico di Lavoro Sicuro	215 kg

Per le certificazioni fare riferimento a quanto specificato nella Sezione "Certificazioni e Sistema qualità"

Le immagini riprodotte in questa scheda sono puramente indicative. È facoltà del produttore apportare ai progetti modifiche senza alcun preavviso. Per l'identificazione delle dotazioni di serie e per la scelta di eventuali ulteriori componenti riferirsi al catalogo accessori e/o alle proposte commerciali. In caso di dati discordanti fa fede il contenuto delle proposte commerciali.

Dep. 84 rev. 07/12/2021

