

# Stephen H Ybrid

A hybrid device for a different hospitalization



## CHAIR

### Frequent usage

Chemotherapy

Blood transfusion

Day Hospital

Blood donor

Blood samples

Dialysis

Patient's transport

Multifunctional





10 BUTTONS HANDSET WITH 2 MEMORIES



MOTORIZED COLUMNS ALLOWING HEIGHT ADJUSTMENT.

## Benefits



- The Stephen H Ybrid device represents an innovative furnishing solution that reduces the patient's psychological distress. Transforming itself into a practical armchair, it offers particular and favorable postural conditions in every clinical situation.
- Perfectly suitable for patient's transport.
- It is available with side rails or armrests.
- Anti-tilt frame, it prevents any tilt in every operative conditions.
- Through no.5 low voltage motors activated via handset the chair/bed can be set in several positions.
- It is possible to place the patient into clinostatic position through the emergency buttons located on both sides of the device. In alternative, it is possible to have the Trendelenburg or Shock position.
- The Stephen H-Ybrid it's a particularly unique device. It features a sturdy surface in HPL panels which support the removable mattress.
- The device can be provided with a wide range of accessories (see accessories list).
- The upholstery is out of washable and certified leatherette, with antibacterial and antifungal properties. It is extremely resistant and has the following characteristics: antibacterial, class 11M fire retardant, antifungal.
- It is also resistant to: alcohol, hydrogen peroxide, hypochlorite
- sodium max 5%, and to the commonly used disinfectant products.

## Available armrests



### AC30/H1



Rotating armrest. Removable and adjustable in height. This accessory is not compatible with the side rails.

### AC30/EH



Motorized armrest integrated to the lying surface. They can be adjusted in height and rotate to 30°. The movement is synchronized to the backrest assuring high comfort during transfusion therapy.

## Standard features

- Painted steel frame in thermosetting powder. Wide range of colours at page 5.
- No.4 motors for the movements of the following sections:
- Movimentazione simultanea schienale/gambe (DA ELIMINARE?)
  - Motor for the independent movement of the leg section and the back section Equipment code AC12.
  - Motor for the inclination of the seat Equipment code AC35/1.
  - Motor for the regulation of the footrest equipment code AC13.
  - Height adjustment performed by two motorized columns Equipment code AC28/300.
- No. 4 Ø 100 mm swivable wheels in stainless steel.
- Centralized braking system through bilateral pedals with directional system Equipment code AC7P2G.
- Bilateral emergency button for clinostatism Equipment code AC74.
- Transport handle Equipment code AC56.
- Chair's movements are controlled by a 10 buttons handset with a 3,5 mtl coiled cable; For patient's safety purpose the handset is provided with an inhibition key, equipment code AC34P. The handset is user friendly and has visual pictograms useful for partially sighted people. Insulation IP66.
- Bilateral support for handset located on the armrest. It can be easily reached by the patient. Equipment code AC25P.
- Supplementary headrest cushion adjustable in height. It is made out of expanded foam with antibacterial cover Equipment code AC27.
- Soft and removable cushion for footrest Equipment code AC16/1.
- Adjustable armrests Equipment code AC30/H1.
- ABS cover for base Equipment code AC83/H.
- ABS cover for seat Equipment code AC84/H.
- ABS cover for back section AC86/H.
- Upholstery in flame retardant leatherette UNI 9175/87 e 9175FA-1/94 class 11M - Equipment code AC87/1.



**ELECTRICALLY ADJUSTABLE ARMREST PROVIDED WITH HPL PROTECTIVE PANEL**



**BILATERAL PEDAL FOR CENTRALIZED BRAKE ACTIVATION. IT CAN BE LOCATED FRONTALLY OR BEHIND THE DEVICE**



## Movements

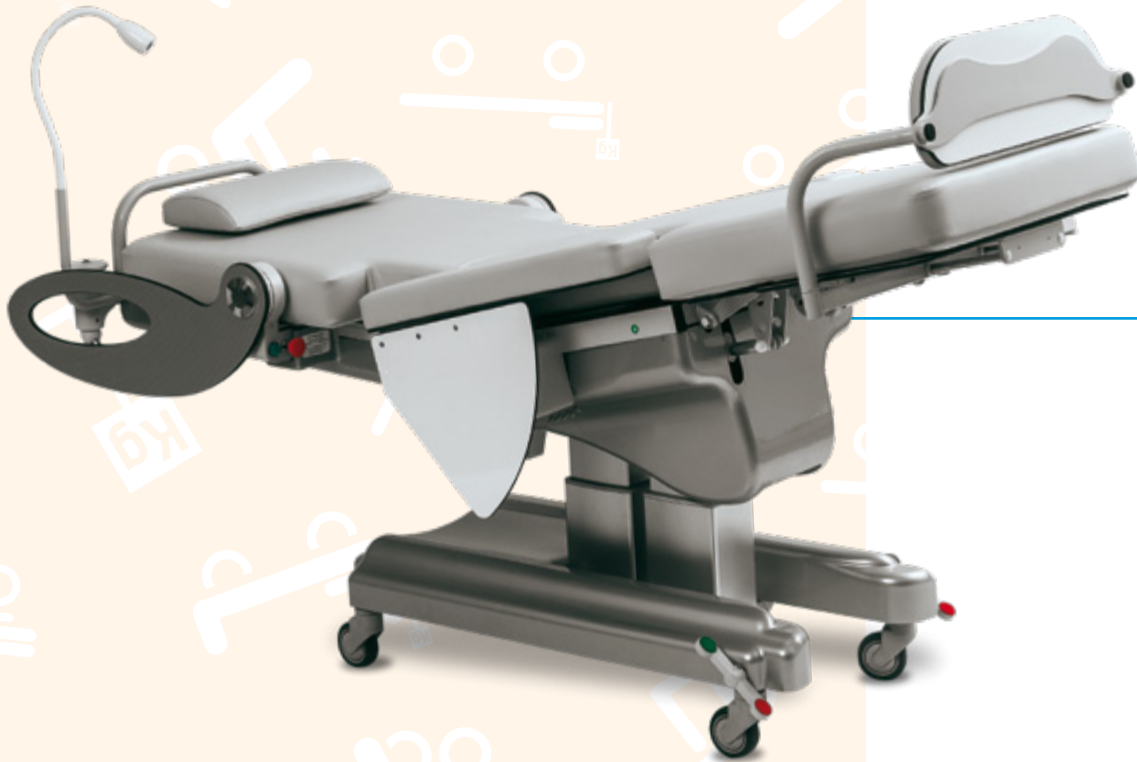

SHOCK POSITION



CLINOSTATIC















## Colour chart





























### FRAME COLOURS



















The entire structure of the chair is protected by epoxy and thermosetting paints. The paints are enriched with antibacterial upon request. Whether not specified the frame of the device will be painted in white 9010.

|   |   |   |
|---|---|---|
|  Code 2004 |  Code 5012 |  Code 7035 |
|  Code 3020 |  Code 6027 |  Code 9005 |
|  Code 1018 |  Code 6018 |  Code 9010 |
|  Code 1021 |  Code 7001 |  Code 4010 |
|  Code 5010 |  Code 9006 |   |

### COLOURS FOR STANDARD UPHOLSTERY

|   |   |   |
|---|---|---|
|  Code 5947   |  Code 0872   |  Code 0014     |
|  Code 5948   |  Code 4947   |  Code 0027     |
|  Code 0680 |  Code 1944 |  Code 0006   |
|  Code 0508 |  Code 4008 |  Code 0346   |
|  Code 0041 |  Code 1946 |  Code 016043 |
|  Code 0064 |  Code 4933 |  Code 011499 |
|  Code 0055 |  Code 0430 |  Code 015815 |
|  Code 1816 |  Code 0151 |  Code 015814 |
|  Code 0833 |  Code 0667 |  Code 016042 |

### COLOURS FOR SILICONIC UPHOLSTERY (THEY HAVE A HIGHER PRICE) ACCESSORY CODE AC87

|  |  |   |
|--|--|---|
|  Code 7039.08 |  Code 7039.14 |  Code TH.439 |
|  Code 7039.06 |  Code TH.513  |  Code TH.438 |
|  Code 7039.17 |  Code TH.511  |  Code TH.322 |
|  Code 7039.20 |  Code TH.305  |  Code TH.224 |
|  Code 7039.10 |  Code TH.378  |  Code 312    |
|  Code 7039.19 |  Code TH.300  |  Code TH.226 |
|  Code 7039.13 |  Code TH.510  |   |



REMOVABLE IV POLE AND COURTESY LAMP



HEAD SECTION WITH INTEGRATED TRANSPORT HANDLE



ERGONOMIC TRANSPORT HANDLE WITH HIGH BACKREST



BILATERAL BUTTON WITH LUMINOUS ALARM FOR AUTOMATIC CLINOSTATISM OR AS ALTERNATIVE: SHOCK POSITION OR TRENDELENBURG

# Dimensions



## Version with AC30/HI

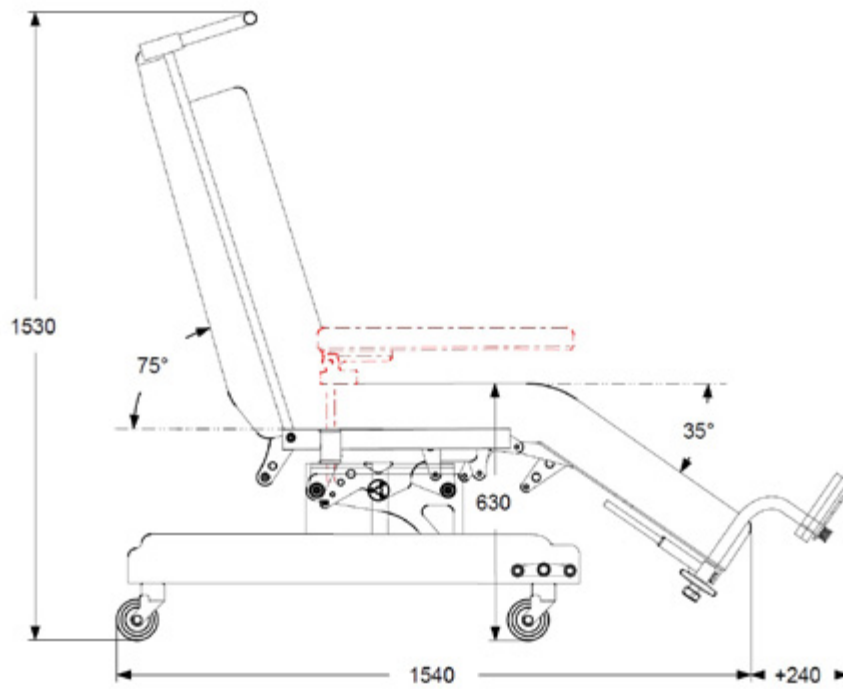
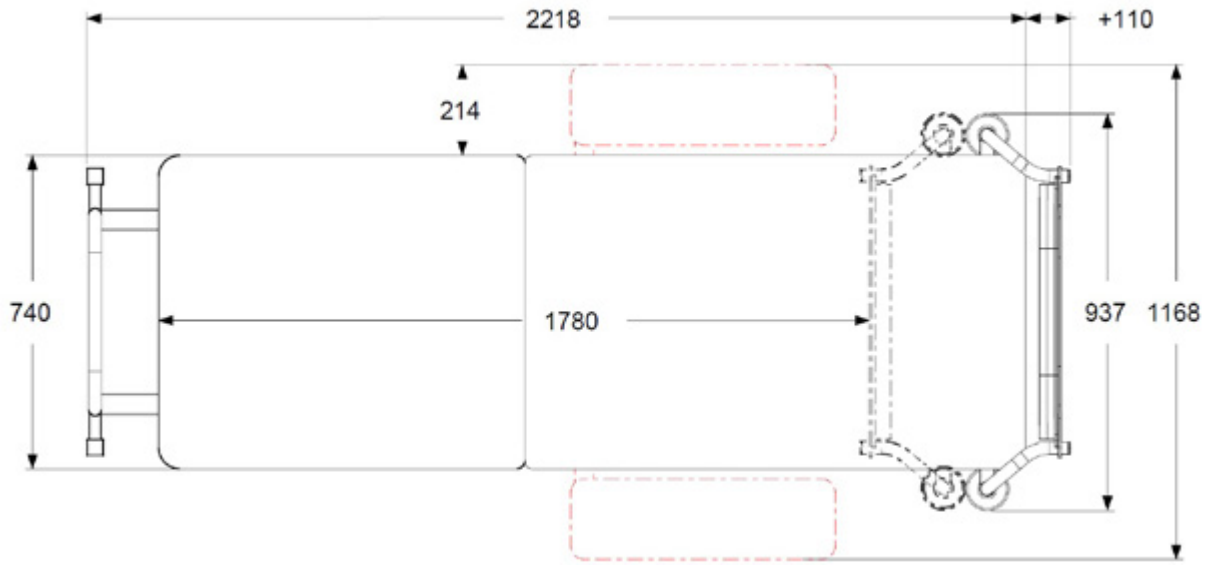

# Dimensions



## Version with AC30/EH - AC21/HP2

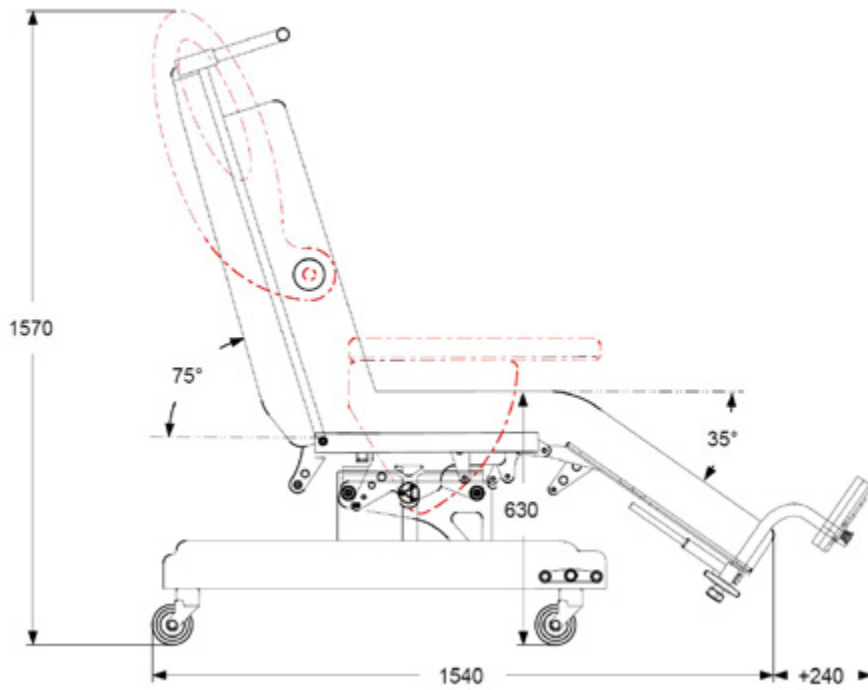
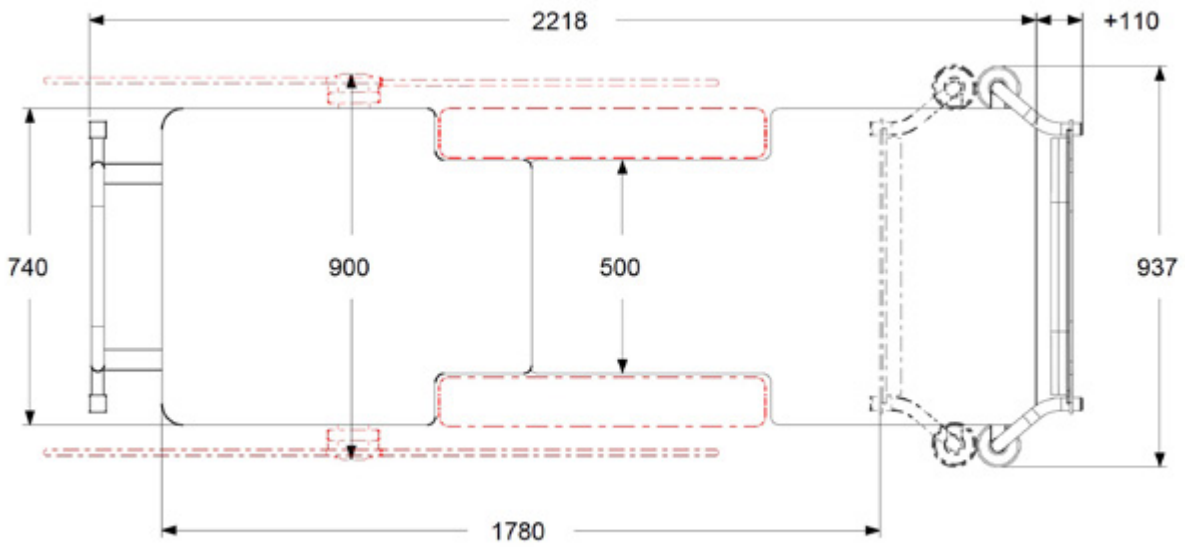

## MAIN CORD



Type F - Schuko



Type L - 16A



Type I - Australia

Type B - Canada  
and USA

Type G - UK plug

## Technical sheet



|                      |  |
|----------------------|--|
| GMDN Code            | <b>38448</b>   |
| ID Code              | <b>GB0008.SP</b> Painted steel<br><b>GB0008.SS</b> Stainless steel |
| Inteded use          | Bed/Multifunctional chair  |
| Manufacturer         | GARDHEN BILANCE SRL  |
| Overall weight       | 140 kg   |
| Wheels               | No. 4 Ø 100 mm swivable and stainless<br>with braking system       |
| Power                | 100 - 240 Vac 50/60 Hz   |
| Electric motors      | Low voltage 24V  |
| Max electrical input | 4A   |
| Insulation           | IP44   |
| Max Load             | 300 kg   |
| Safety Working Load  | 335 kg   |

For certifications please refer to "Certifications and Quality system" section

Pictures contained in this brochure is for illustrative purpose only. The manufacturer reserves the right to modify the projects without notice. For accessories identification please refer to the accessory catalogue or commercial offer. When data are different please refer to commercial offer.

Dep. EN\_86 rev. 16/10/2021

