

Francis

Doctor's visit couch

4



Italian design
and technology
in the world



FREQUENT USAGE

day hospital	★★★★
clinic	★★★★
medical practice	★★★★
infirmary	★★★★
chemotherapy	★★★★
endoscopic examination	★★★★
ultrasound diagnostic	★★★★

*** = very frequently used

** = frequently used

* = rarely used



QUICK RELEASE OF THE BACKREST,
IT ALLOWS TO EASILY PERFORM
THE CPR MANOEUVRE
EQUIPMENT CODE AC8L

Benefits

- **Easy access**
The height of the lying surface can be adapted in order to make the seat easy for people of different height and for users with reduced mobility.
- **Lifetime**
High performances and long lifetime are ensured by its sturdy structure and by the robust frame.
- **Safety**
The frame is crushproof and it is designed to avoid any tilt and it is safe also for over-size patients.
- **Hygiene**
The coating is made out of special leatherette. It is certified as antibacterial and antimycotic(*) and it is easy to clean.

Standard features

- Reinforced frame, made out in steel painted with epoxy paint enriched with antibacterial. The colour is customizable upon request - colour chart at page 4.
- Lying surface divided in 2 sections with servo-assisted backrest's adjustment.
- Backrest quick release function. It allows to easily perform the CPR manoeuvre - equipment code AC8L.
- Fixed height base.
- Glides.
- Leatherette upholstery class 11M; antimycotic, antibacterial, stain resistant. It can be sanitized with the most common type of detergents. The colour is customizable upon request - Colour chart at page 4.
- Mattress made out in high density expanded foam.
- Paper roll holder located behind the backrest - equipment code AC11.

Recommended accessories

AC107



Motorized backrest. It can be activated through footswitch located in front of the device.

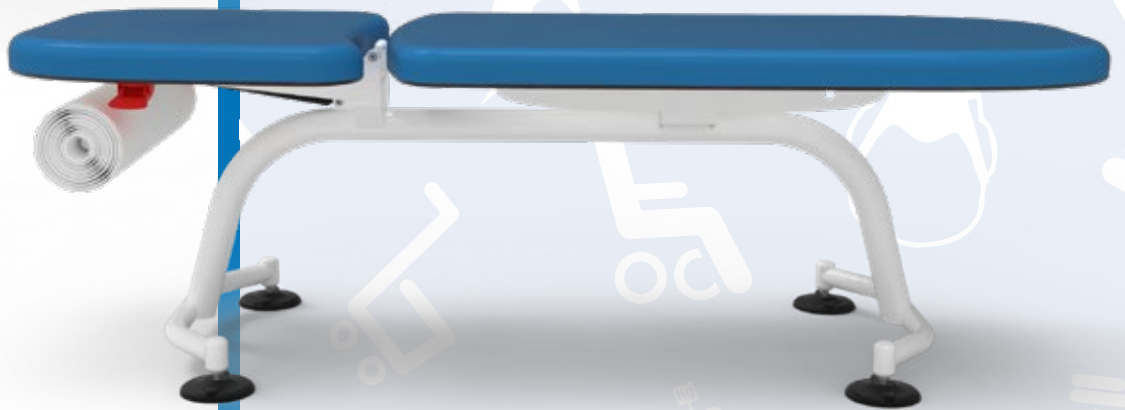

Recommended accessories



AC50L

















Cable support

Colour chart





























FRAME COLOURS

The entire structure of the chair is protected by epoxy and thermosetting paints. The paints are enriched with antibacterial upon request. Wether not specified the frame of the device will be painted in white 9010.

 Code 2004	 Code 5012	 Code 7035
 Code 3020	 Code 6027	 Code 9005
 Code 1018	 Code 6018	 Code 9010
 Code 1021	 Code 7001	 Code 4010
 Code 5010	 Code 9006	

COLOUR FOR STANDARD UPHOLSTERY

 Code 5947	 Code 0872	 Code 0014
 Code 5948	 Code 4947	 Code 0027
 Code 0680	 Code 1944	 Code 0006
 Code 0508	 Code 4008	 Code 0346
 Code 0041	 Code 1946	 Code 016043
 Code 0064	 Code 4933	 Code 011499
 Code 0055	 Code 0430	 Code 015815
 Code 1816	 Code 0151	 Code 015814
 Code 0833	 Code 0667	 Code 016042

Dimensions

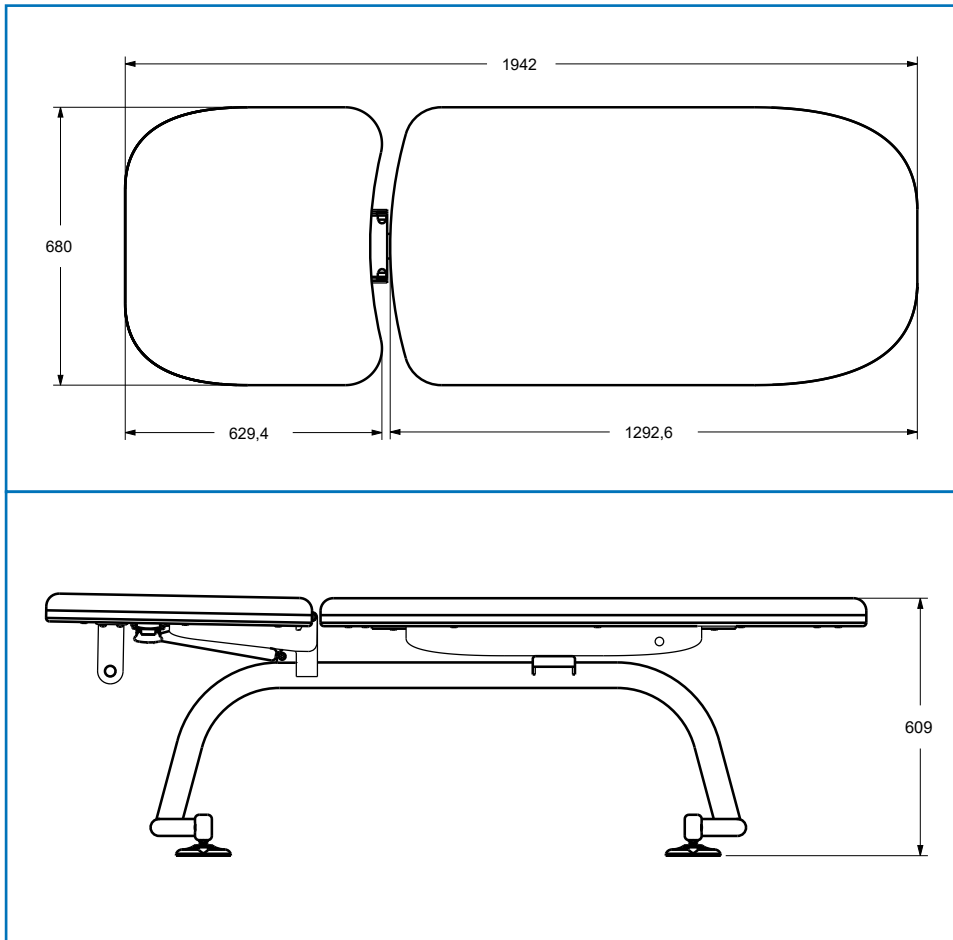

Technical data

• Data

GMDN Code	34134
Intended use	Examination couch
Manufacturer	GARDHEN BILANCE SRL
Main supply	230 Vac 50-60 Hz
Motors	Low tension (24V)
Max electrical input	480 VA
Insulation	IPX4
Max load capacity (Standard version)	200 Kg
Safety working load (Standard version)	235 kg
Max load capacity (Bariatric version)	300 Kg
Safety working load (Bariatric version)	335 kg

Pictures contained in this brochure is for illustrative purpose only. The manufacturer reserves the right to modify the projects without notice. For accessories identification please refer to the accessory catalogue or commercial offer. When data are different please refer to commercial offer.

Dep. 108_EN rev.01/09//2021

For certifications please refer to "Certifications and Quality system" section

